

ROPE CLAMPS

EN Handled rope clamps / rope clamps.



CE 0333

MADE IN ITALY
EN 12841:2006-B
EN 567:2013
PATENTED

Regulation (EU) 2016/425
 Personal Protective Equipment against falls from a height.



4 MARKING / NOMENCLATURE OF PARTS

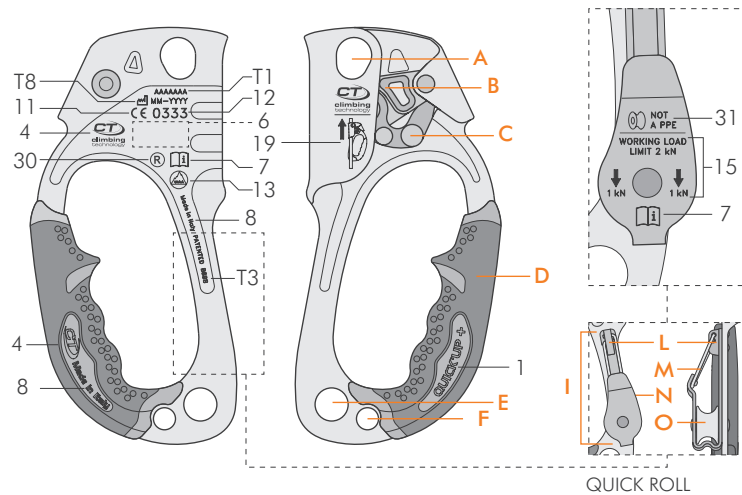

4.1 - QUICK'UP+ / QUICK ROLL

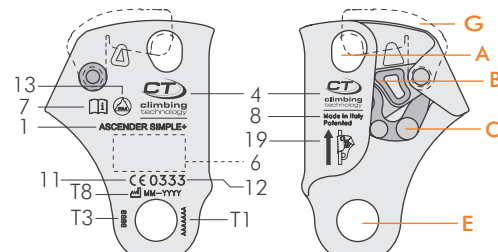

4.2 - ASCENDER SIMPLE+

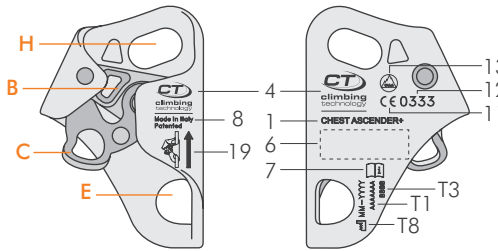

4.3 - CHEST ASCENDER+/HC

5 BREAKING STRENGTH

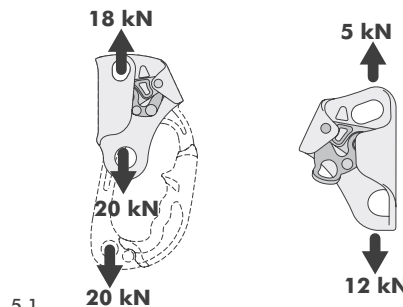

5.1

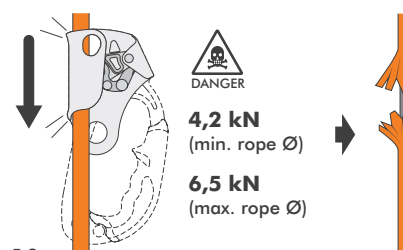

5.2

6 ASCENDER SIMPLE+ / QUICK'UP+ - INSTALLATION AND TESTING

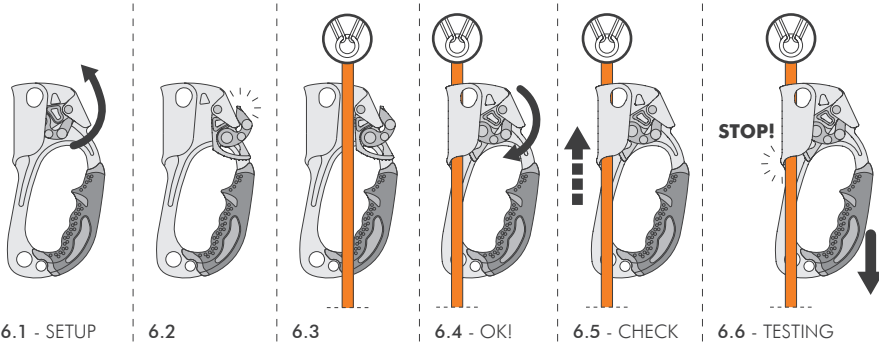

6.1 - SETUP

6.2

6.3

6.4 - OK!

6.5 - CHECK

6.6 - TESTING

7 ASCENDER SIMPLE+ / QUICK'UP+ - INSTRUCTIONS OF USE

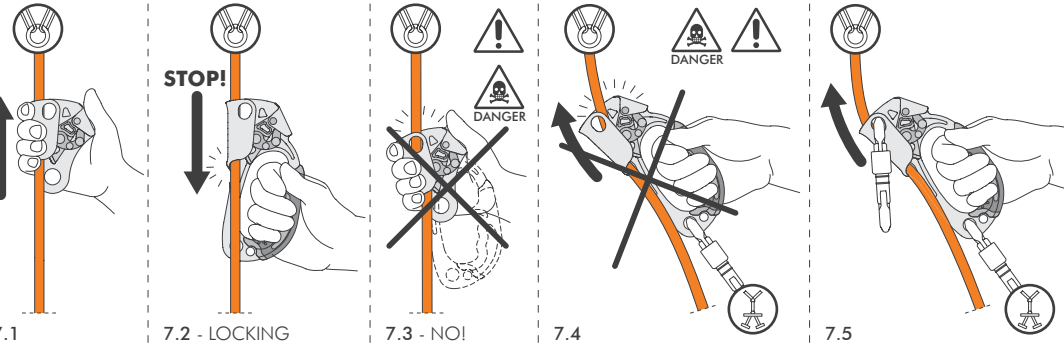

7.1

7.2 - LOCKING

7.3 - NO!

7.4

7.5

8 ASCENDER SIMPLE+ AND QUICK'UP+ ATTENTION!

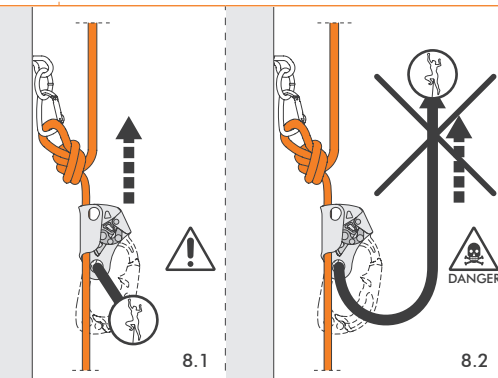

8.1

8.2

9 CHEST ASCENDER+/HC - INSTALLATION AND TESTING

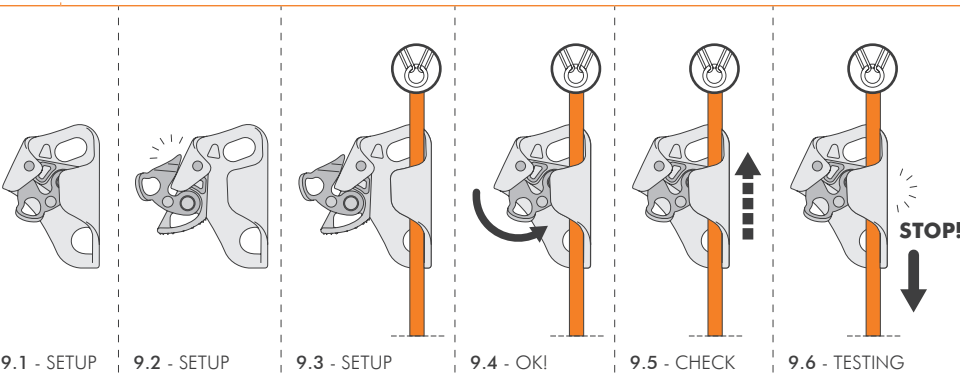

9.1 - SETUP

9.2 - SETUP

9.3 - SETUP

9.4 - OK!

9.5 - CHECK

9.6 - TESTING

10 CHEST ASCENDER+/HC - INSTRUCTIONS OF USE

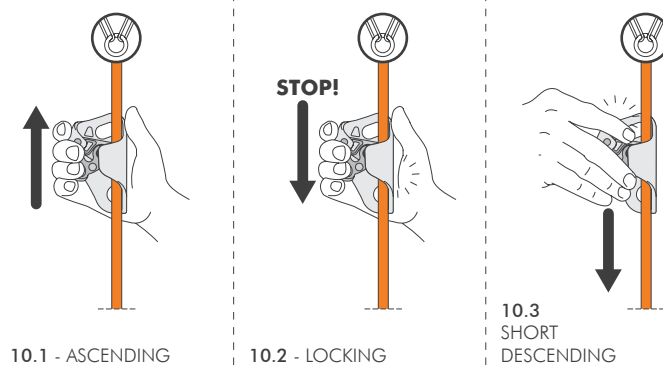

10.1 - ASCENDING

10.2 - LOCKING

10.3 SHORT DESCENDING

11 PATENT - EASY RELEASE UNDER TENSION

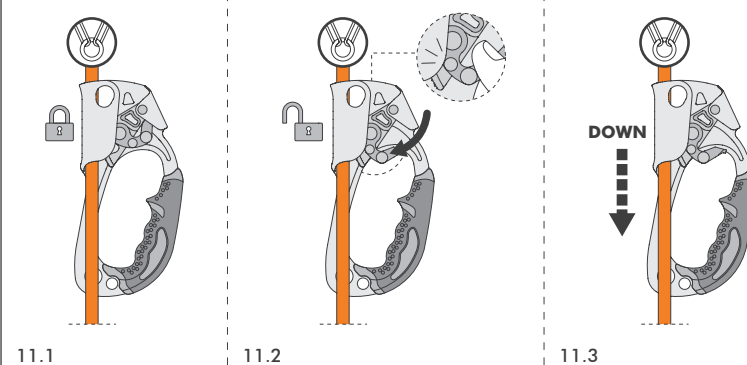

11.1

11.2

11.3

1 MODELS CHART

Product model	Ref. No.	Weight	Standard
QUICK'UP+	2D639S	215 g	EN 567 EN 12841-B
QUICK'UP+	2D639D		
CHEST ASCENDER+ CHEST ASCENDER HC	2D640N	140 g	
ASCENDER SIMPLE+	2D642D*	150 g	
		160 g	
QUICK ROLL	2D663D	255 g	
QUICK ROLL	2D663S		

2 ROPE COMPATIBILITY

STANDARD EN 567:2013	EN 892 - Ø 8-13 mm
	EN 1891 - Ø 8-13 mm
STANDARD EN 12841:2006-B	ROPE EN 1891-A Ø 10-13 mm

3 EN 12841 - MAX RATED LOAD

EN 1891	
Ø 10 + 13 mm	max 140 kg

ENGLISH

The instruction manual for this device consists of general and specific instructions, both must be carefully read and understood before use. **Attention!** This leaflet shows the specific instruction only.

SPECIFIC INSTRUCTIONS EN 567 / EN 12841-B. This note contains the necessary information for a correct use of the following product/s: ascenders.

1) FIELD OF APPLICATION. This product is a personal protective device (PPE) against falls from height; it is compliant with the Regulation (EU) 2016/425. **Attention!** For this product the indications of the standard EN 365 must be respected (general instructions / paragraph 2.5).

Attention! For this product a periodic thorough inspection is compulsory (general instructions / paragraph 8.) EN 12841:2006-B - Rope access system / rope adjustment device type B / working line ascender. Must be used with ropes (core + sheath) static or semi-static (EN 1891) or dynamic (EN 892) Ø 8-13 mm. **Risk of death!** The ascending system with pulley is not a PPE (Personal Protective Equipment) and it can only be used as described in paragraph 7.2)

2) NOTIFIED BODIES. Refer to the legend in the general instructions (paragraph 9 / table D); M1; N1.

3) NOMENCLATURE OF PARTS (Fig. 4). A) Double upper slot. B) Locking cam. C) Opening/safety/release lever. D) Grip. E) Lower slot. F) Bracket attachment slot. G) Safety cover. H) Upper slot. I) Ascender system with pulley. J) Lever support. M) Lever. N) Body. O) Pulley.

4) MARKING. Numbers/letters without caution: refer to the legend in the general instructions (paragraph 5).

4.1 - General (Fig. 4). Indications: 3; 4; 6; 7; 8; 11; 12; 13; 15; 19; 30) Hand of use: R (for the R hand) or L (for the L hand). 31) Note indicating that the ascending system and the pulley are not PPE.

4.2 - Traceability (Fig. 4). Indications: T1; T3; T8.

5) CHECKS. Further to the checks indicated below, comply with what indicated in the general instructions (paragraph 3). Check carefully before each use, the cam teeth are present and show no signs of wear; the connector placed in the attachment slot is free to rotate unimpeded; only for the Quick Roll model, there is no gap between the ascender system and the handled ascender on which it is attached. **During each use,** ensure the rope is always in tension to avoid possible free-falls; avoid having slack rope between the anchor and the attachment on the harness; take great care to prevent the rope coming out when using it transversally on stretched ropes.

6) USER INSTRUCTIONS. The user must always be positioned below the anchor point (Fig. 15). **Attention!** Do not use on metal cables or plied ropes.

6.1 - Insertion of the rope. Turn the lever to open the cam (Fig. 6.1-9.1). Couple the lever with the body of the device (Fig. 6.2-9.2). Insert the rope in the correct up/down direction (Fig. 6.3-9.3) and release the lever to close the cam (Fig. 6.4-9.4).

6.2 - Function testing. Run a locking test to make sure the rope is in the R direction (Fig. 6.5-6.6/9.5-9.6). Relieve the load from the device to open it and release the rope. To facilitate cam opening, push the rope clamp upwards and operate the lever at the same time.

6.3 - Ascend (with the aid of another suitable device). The device runs freely upwards (Fig. 7.1-10.1) and locks in position (Fig. 7.2-10.2). Be careful when approaching the anchor and/or friction points (Fig. 8.1). In no case should the rope clamp be used when the potential fall factor is greater than 1, i.e. the user must stay at all time below the device and/or the anchor point (Fig. 8.2). **Attention!** A fall factor greater than 1 may cause the rope to break. **Only for 2D639**/2D642** models:** In order to ascend on a vertical rope, pull downwards parallel to the rope (Fig. 7.2). In order to ascend on a non-vertical rope, you must constrain the direction of the rope by inserting a connector into the top double slot (Fig. 7.5). **Only for 2D640** models:** Secure the device to the harness through a semicircular quick-link (Fig. 12.1) or through a connector with a locking gate (automatic or manual); the quick-link or the connector must be introduced into the lower hole. Connect the upper hole to the pectoral of the harness in a way that the device adheres vertically to the bust (Fig. 12.2). **Attention!** In order to ascend on a non-vertical rope, hold in the hand the horizontal part of the rope and pull it as much as possible towards a vertical position, in order to avoid the risk that the locking cam opens. **Attention!** The model 2D642D5 presents a safety cover that prevents, in case of special situations (ex. realizations of pulley systems), the exit of the rope (Fig. 19).

6.4 - Attention. This device is not designed for use during descents but it can be used for short sections as follows: relieve the load from the device to partially open the lever, operate



by Aludesign S.p.A. via Torchio 22
 I 24034 Cisano B.sco BG ITALY
 Central tel: +39 035 78 35 95
 Central fax: +39 035 78 23 39
 www.climbingtechnology.com

12 ASCENDER SIMPLE+ / PRECAUTIONS OF USE

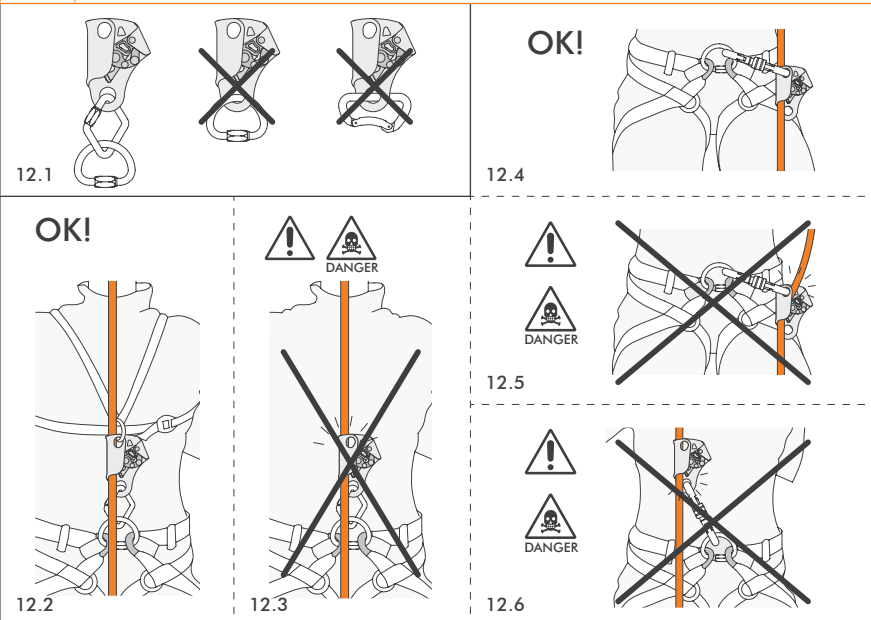

13 CHEST ASCENDER+ / HC PRECAUTIONS OF USE

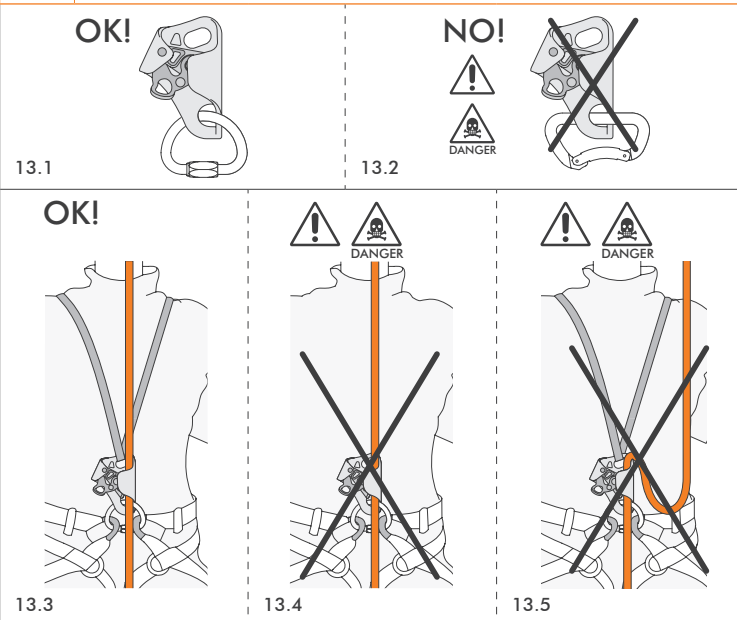

14 ASCENDER SIMPLE+ / HC QUICK'UP+ - OTHER USES

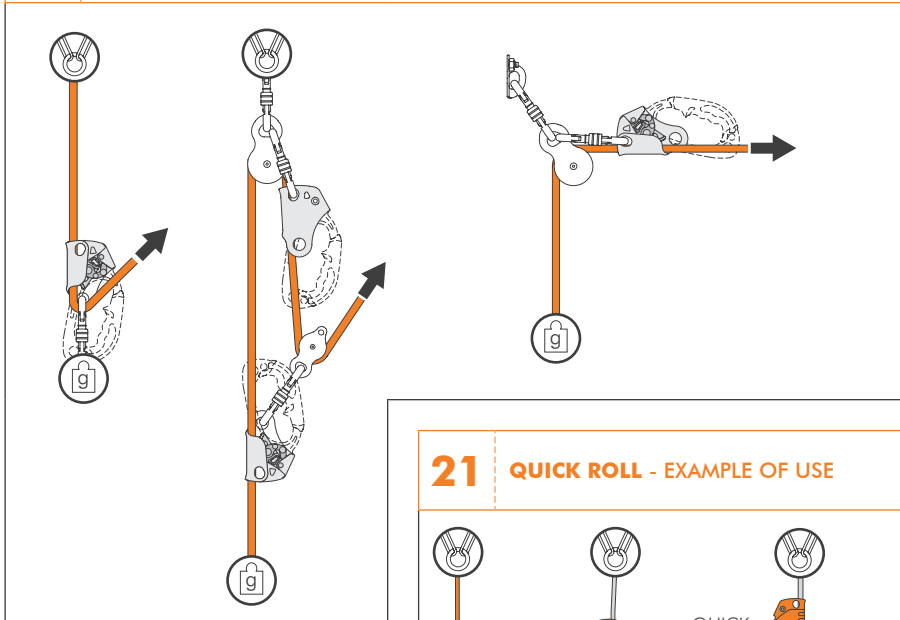

15 ATTENTION!

Anchor point EN 795 min. 12 kN or 18 kN (non metallic anchors)

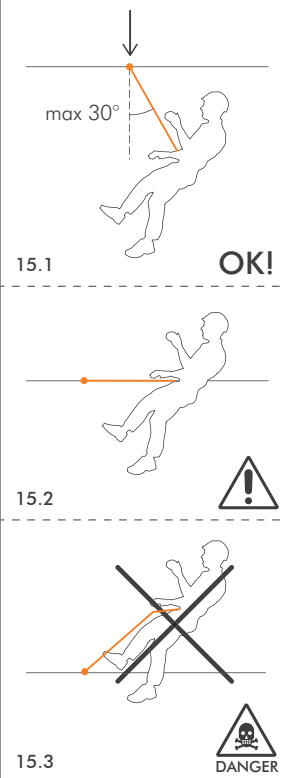

16 ASCENDING A ROPE ROPE ACCESS TECHNIQUE

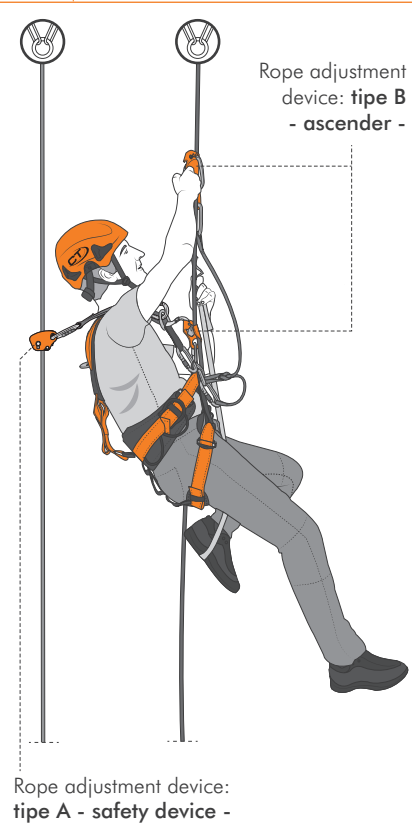

17 ASCENDING A ROPE SIMULTANEOUS SPELEO PROGRESSION

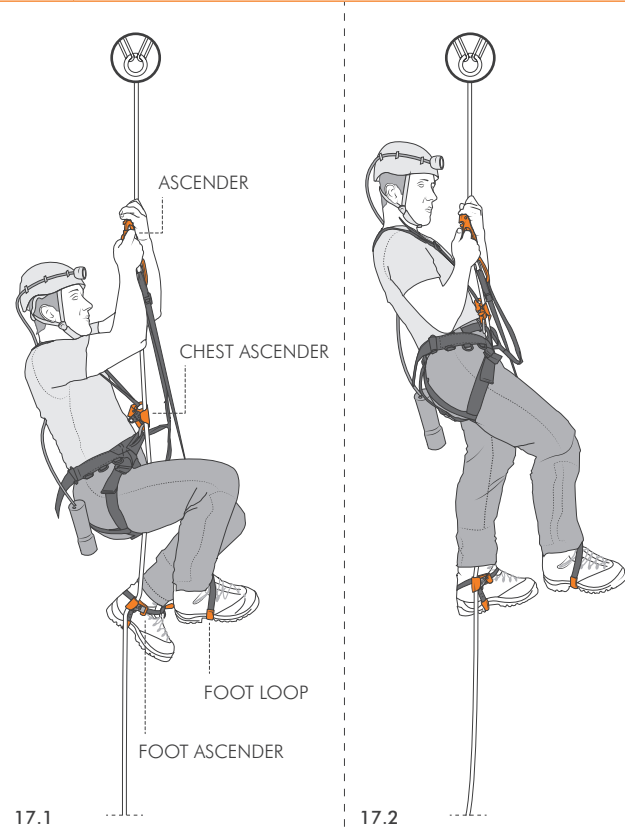

18 ASCENDING A ROPE ALTERNATE SPELEO PROGRESSION

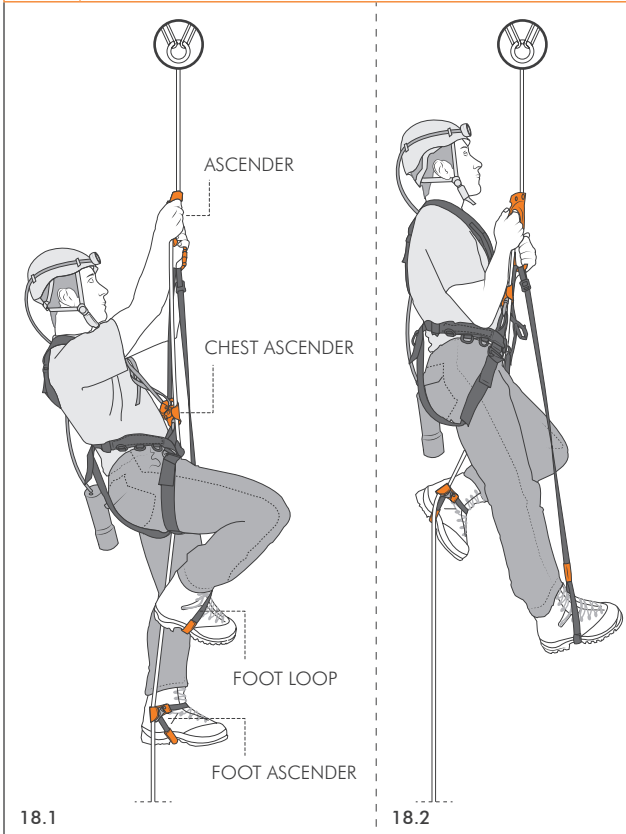

19 ASCENDER SIMPLE+ SAFETY COVERS

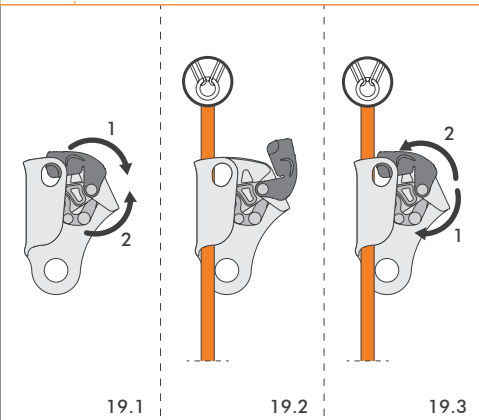

20 QUICK ROLL - WARNINGS

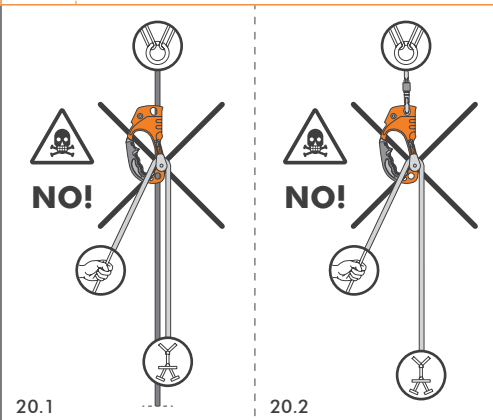

23 OPERATING TEMPERATURE

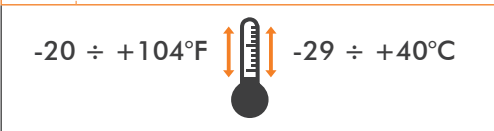

ing it internally so as not to move the safety lock, move the rope clamp down (2) and reapply the load (Fig. 10.3-11).
6.5 - Release under load (PATENTED). The device comes with a mechanism that enables it to open even when it is not possible to relieve the load completely. Move the ratchet grip inward to turn the cam and move it away from the rope, which allows it to release and open out (Fig. 11.1-11.3). The force applied depends on the load on the device, but it must always be enough to prevent any accidental opening. With this system the cam does not open if the load applied (e.g. the weight of an operator) is too high. Releasing in the presence of an excessive load may damage the rope slightly.
6.6 - Speleo progression technique. A chest ascender device is used for ascending on a single rope in combination with a L or R ascent handle, a rope clamp for R or L foot and a foot loop. Progression can be: simultaneous, by pushing both legs together (Fig. 17.1-17.2); alternate, by pushing one leg after the other sequentially (Fig. 18.1-18.2).
6.7 - 2D639 2D642** - Other types of use.** Some of the operating modes of this device are shown in this manual: A) User safety when ascending stairs, ramps or during climbs. B) Construction of hoists for rescue and first-aid interventions (Fig. 14). C) Use during vertical ascents for self-safety (Fig. 12.4). The rope clamp must be secured to the harness using the two upper slots, and the rope must pass between the carabiner and the side plate of the device. **Atten-**

tion! Avoid set-ups as shown in figure 12.5-12.6. D) Use as waist rope clamp. This device can be used in the waist position when ascending a rope. To keep it in the correct position (i.e. parallel to the body), use a rectangular quick link to secure it to the correct attachment point on the harness (Fig. 12.1-12.2).
7) QUICK ROLL SPECIFIC INSTRUCTIONS.
 The Quick Roll model is equipped with a lifting system with pulley that can be used both for rope access and for caving activities. **Attention!** The lifting system with pulley is not PPE, and it can only be used as an additional aid to the ascent, as per the methods shown, but not for lifting people and/or material (Fig. 20).
7.1 - Use for rope access (Fig. 21). Install the Quick Roll onto the working rope above the self-braking descender (e.g. Sparrow). If necessary, connect a foot loop to the bottom hole of the ascender. Pass the working rope so that it goes from the descender and in to the ascending system and carry out the ascent as shown.
7.2 - Use for caving (MAO method) (Fig. 22). Install the Quick Roll ascender onto the rope above the chest ascender. Attach a foot loop to the upper hole of the chest ascender. Pass the rope into the ascending system and carry out the ascent as shown.
8) EN 12841:2006 SPECIFIC INSTRUCTIONS.
 These equipment are rope adjustment devices type B, for the ascending of a working line. Rope adjustment devices type B are Personal Protective Equipment (PPE) intended to be incorporated in a rope access system. Rope adjustment devices must not be used for fall arrest. An anchor line loaded with the entire weight of the user, has to be considered a work line and is not meant to arrest a fall. It is mandatory to use a fall arrest back-up device type A connected to a safety line. Pay attention that the back-up system is never loaded on to the work line (Fig. 16). **Warnings:** only anchor points that comply with the EN 795 standard can be used (minimum strength 12 kN or 18 kN for non-metallic anchors) that do not have sharp edges; avoid any overloading or loading on the device because can harm the anchor line; maximum length of the lanyard to extend the harness connection by 1 m (lanyard + connectors + device); during the use, the anchor point must always be placed above the operator; the technical performances of the anchor line might vary considerably, due to dirt, moisture, ice, repeated uses on the same stretch; keep in mind that these variances will influence the behavior of the rope inside the device; max work-load 140 kg.
9) SYMBOLS. Refer to the legend in the general instructions (paragraph 15): F2; F3; F4; F5; F9.

21 QUICK ROLL - EXAMPLE OF USE

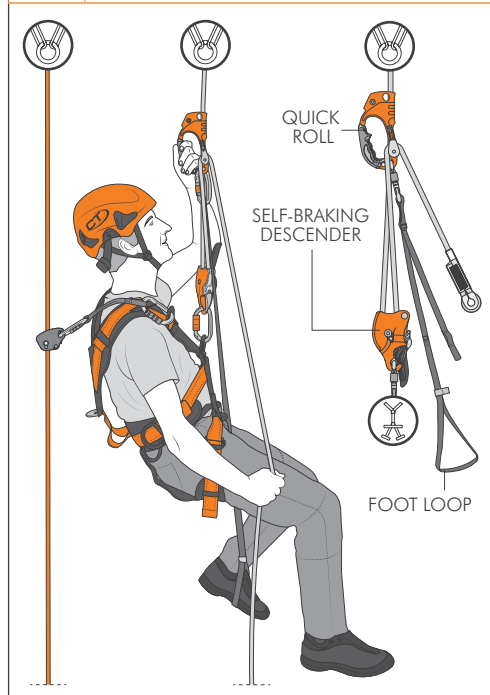

22 QUICK ROLL - EXAMPLE OF USE

